

M4.		
M3.		
M2.		
M1.		
Sz/Nr.	Tárgy/Designation:	Dátum/Date:

MÓDOSÍTÁS/REVISION:

MEGBÍZÓ/CLIENT:  
KÖRNYE KÖZSÉG ÖNKORMÁNYZATA  
2851 KÖRNYE, ALKOTMÁNY UTCA 2.

TERV/PROJECT:

## KÖRNYE, ÁPRILIS UTCA KORSZERŰSÍTÉSÉNEK ÚTÉPÍTÉSI TERVE

TERVEZŐ:

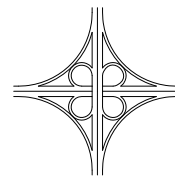

**ÚTHÁLÓZAT**  
Mérnök Iroda Kft.

2800 Tatabánya, Szent Borbála tér 6. II.em. 6.  
Tel.: 34/309-399; Tel/Fax: 34/309-400  
E-mail: tractor@t-online.hu

RAJZ / TITLE

## KERESZTSZELVÉNYEK

FELELŐS TERVEZŐ:

*Szabóné*

**SZABÓNÉ CSERNAI ÉVA**  
KÉ-K 11-0536; K1d-1 11-0536

SZERKESZTŐ:

*Fodor*

**FODOR TIBOR**

MUNKASZÁM/NR.

**625/2016.**

PROJEKT/PROJECT

**0755**

TERVFAJTA / PLAN TYPE

**ENGEDÉLYEZÉSI ÉS KIVITELI TERV**

DÁTUM / DATE

**2016.11.**

LÉPTÉK / SCALE

**1:100**

RAJZSZÁM / DRAWING Nr.

**UEK-006**

FILENÉV / FILE

S:\Land Projects R2\0755 Környe, Április utca\NYOMTATÁS\0755\_MOD\_ENG-KIV\_HRSZ\_HSZ\_KSZ\_MK SZ

MINDEN JOG FENNTARTVA ! EZ A TERV NEM MÁSOLHATÓ, NEM MUTATHATÓ, NEM BOCSÁTHATÓ RENDELKEZÉSRE HARMADIK SZEMÉLYNEK ILLETÉKES HOZZÁJÁRULÁS NÉLKÜL!



# 0+004.00

TÖLTÉS: 0.01 m<sup>2</sup>  
VÁGAT: 0.96 m<sup>2</sup>

MOD\_Aprilis u\_tengely / 1

TM: 156.31 mBf

AM: 155.00 mBf

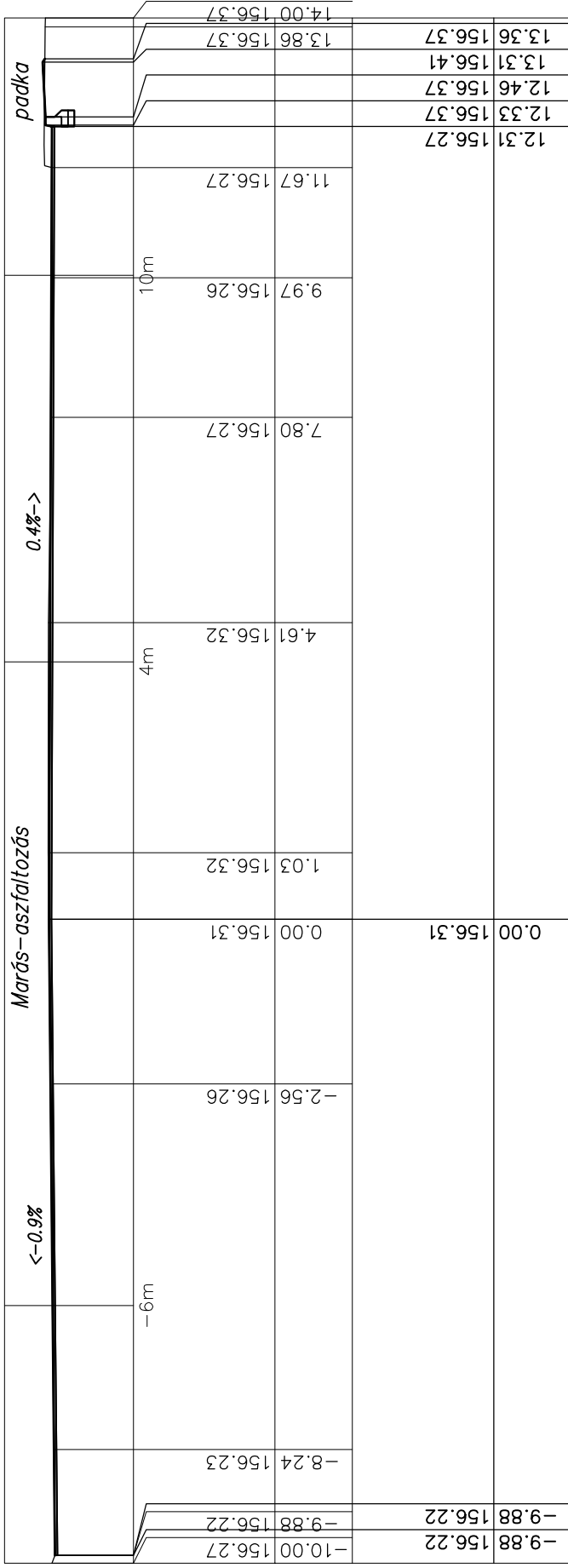

# 0+025.00

TM: 156.69 mBf

TÖLTÉS: 0.07 m2  
VÁGAT: 0.31 m2

AM: 156.00 mBf

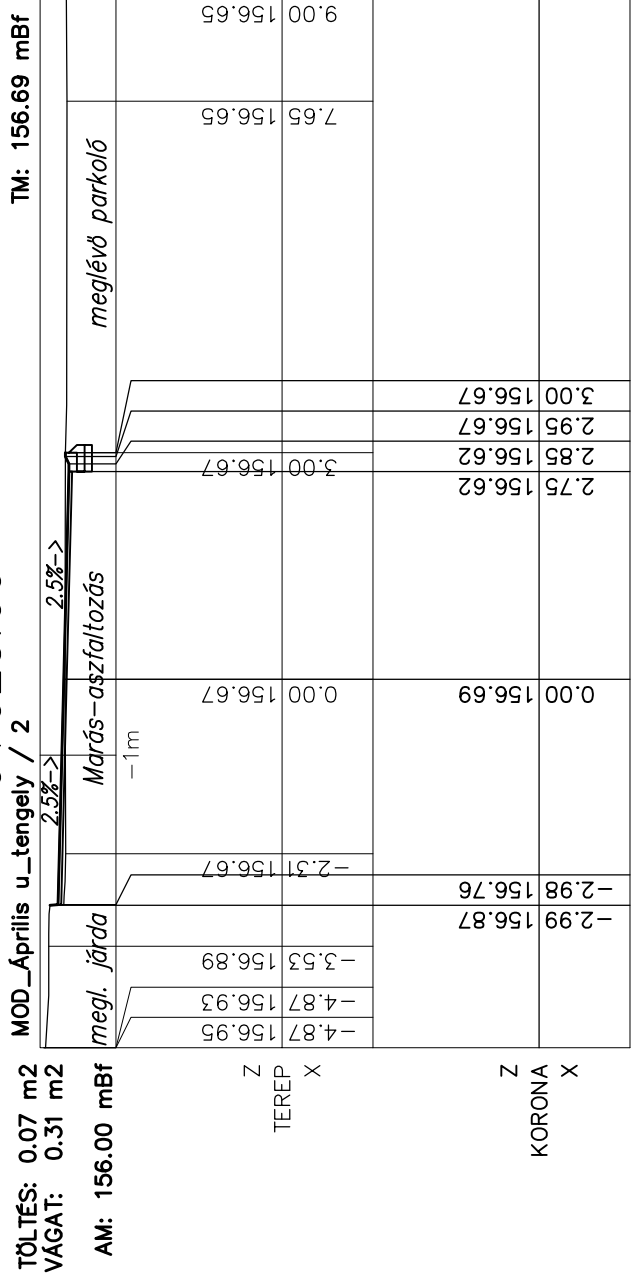

TEREP	X	Z	KORONA	X	Z
-4.87	156.95		-2.99	156.87	
-4.87	156.93				
-3.53	156.89				
-2.31	156.67		-2.98	156.76	
0.00	156.67		0.00	156.69	
3.00	156.67		2.75	156.62	
			2.85	156.62	
			2.95	156.67	
			3.00	156.67	
7.65	156.65				
9.00	156.65				

# 0+050.00

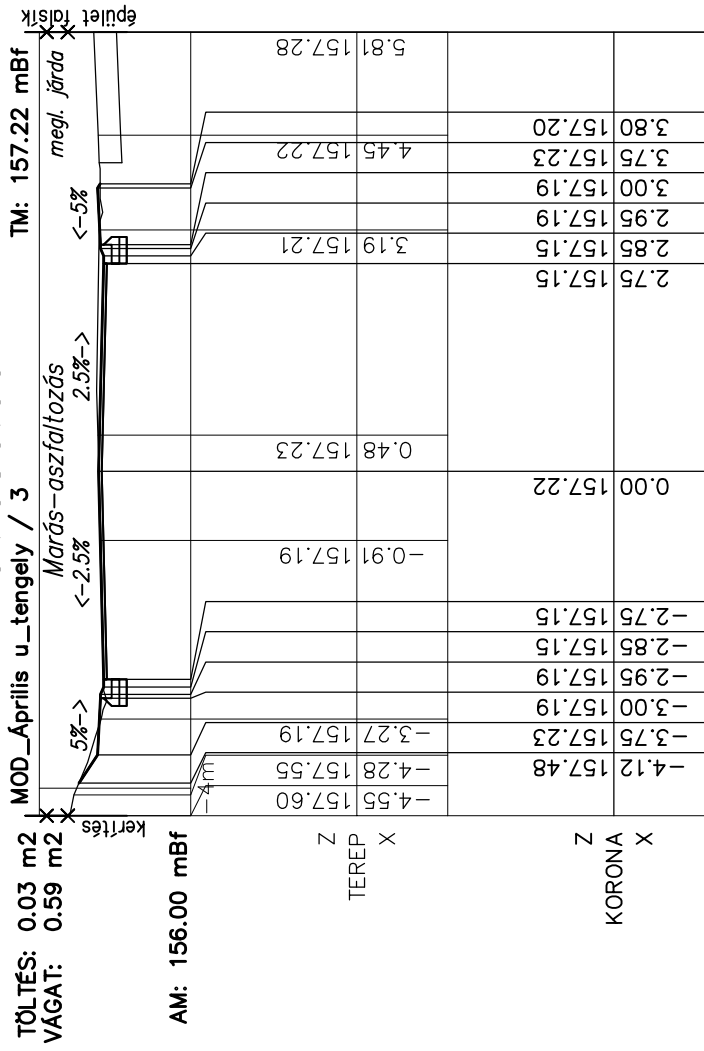

# 0+075.00

**TÖLTÉS:** 0.03 m2  
**VÁGAT:** 0.50 m2  
**AM:** 157.00 mBf

**MOD\_Április u\_tengely / 4**

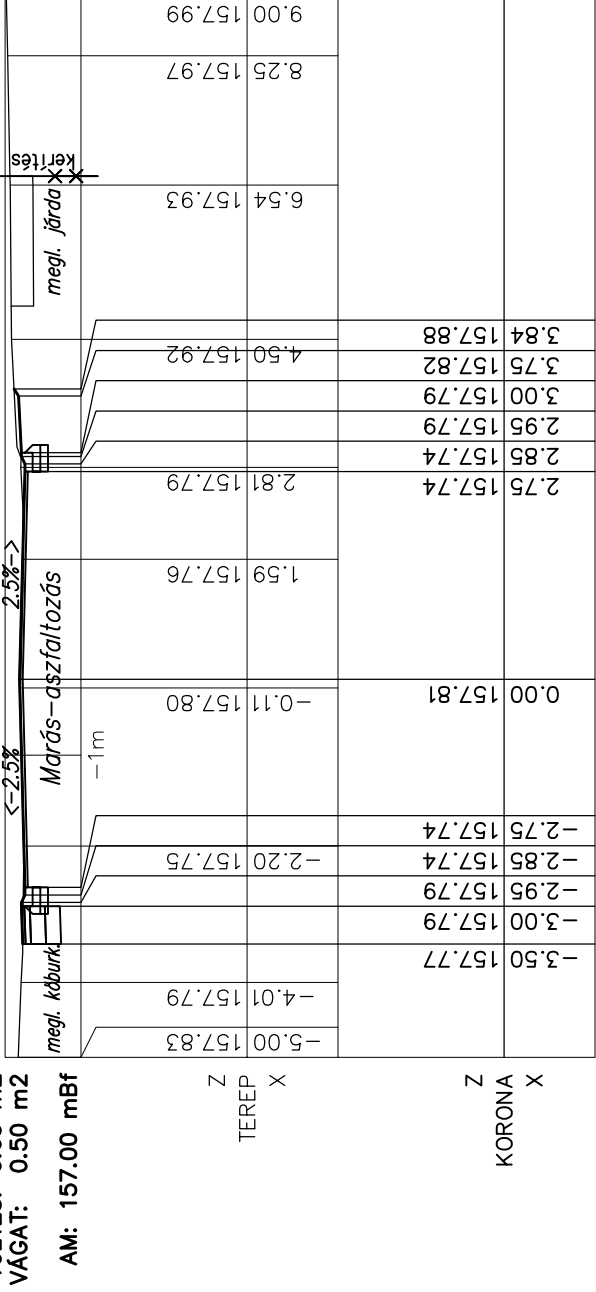

**TM: 157.81 mBf**

**megl. kőburk.**

**Márás-aszfaltozás**

**megl. járda**

**kerítés**

**2.5%**

**2.5%**

**1m**

**9.00 157.99**

**8.25 157.97**

**6.54 157.93**

**4.50 157.92**

**3.84 157.88**

**3.75 157.82**

**3.00 157.79**

**2.95 157.79**

**2.85 157.74**

**2.75 157.74**

**2.81 157.79**

**1.59 157.76**

**0.00 157.81**

**-0.11 157.80**

**-2.75 157.74**

**-2.85 157.74**

**-2.95 157.79**

**-3.00 157.79**

**-3.50 157.77**

**-4.01 157.79**

**-5.00 157.83**

**X**

**Z**

**TEREP**

**X**

**Z**

**KORONA**

0+100.00

TÖLTÉS: 0.11 m2 | MOD\_Április u.\_tengely / 5 | TM: 158.63 mBf

VÁGAT: 0.93 m2

AM: 158.00 mBf

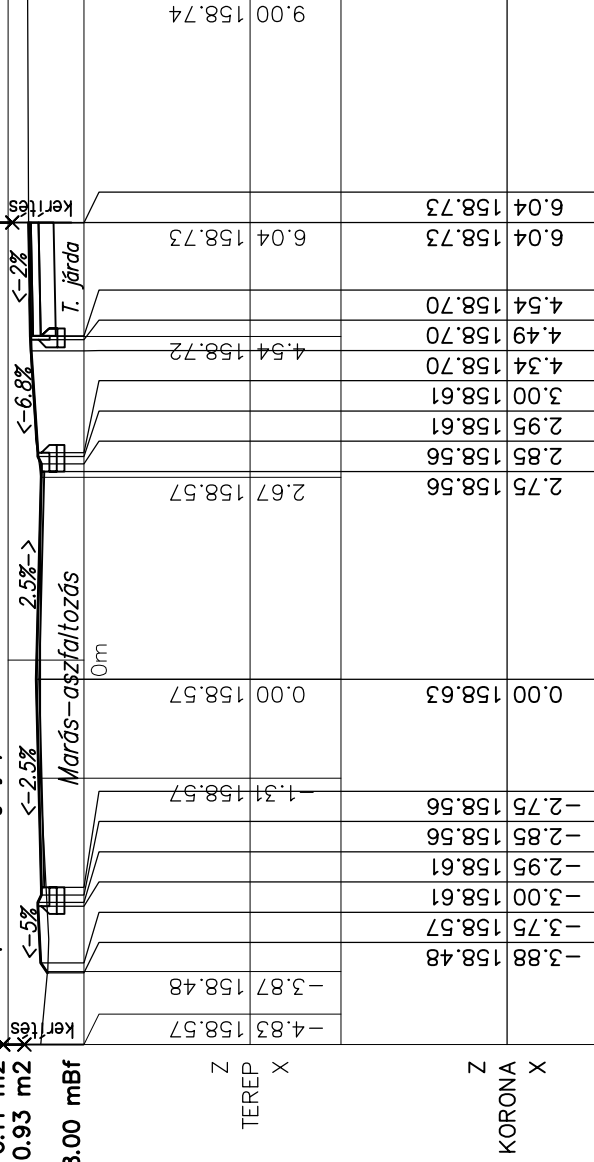

0+125.00

MOD\_Április u\_tengely / 6  
 TÖLTÉS: 0.11 m2  
 VÁGAT: 0.75 m2  
 AM: 159.00 mBf

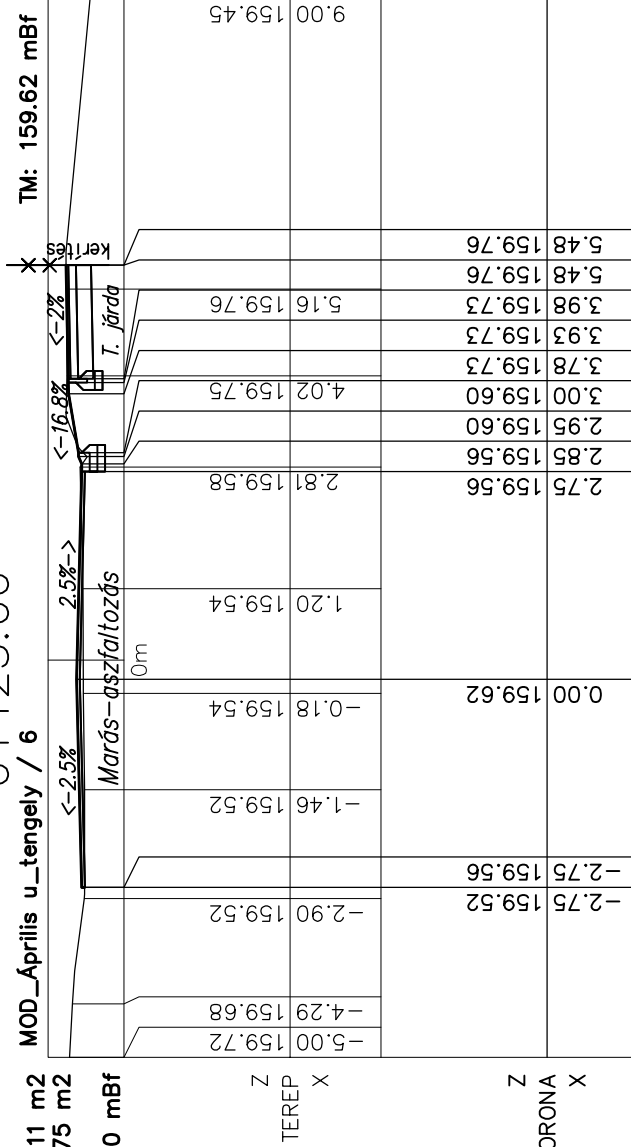

KORONA  
 Z  
 X

TEREP  
 Z  
 X

TM: 159.62 mBf



# 0+150.00

TM: 160.59 mBf

MOD\_Április u\_tengely / 7  
 TÖLTÉS: 0.03 m2  
 VÁGAT: 0.63 m2

AM: 160.00 mBf

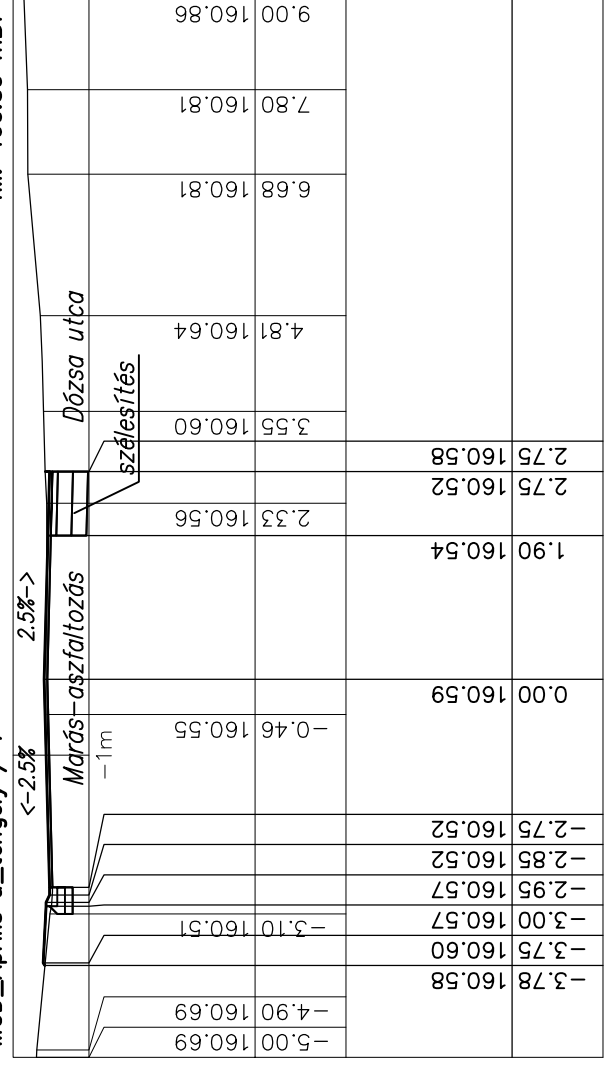

Z  
 X  
 TEREPI

Z  
 X  
 KORONA

0+175.00

MOD\_Április u\_tengely / 8  
 TÖLTÉS: 0.15 m2  
 VÁGAT: 1.07 m2

TM: 161.49 mBf

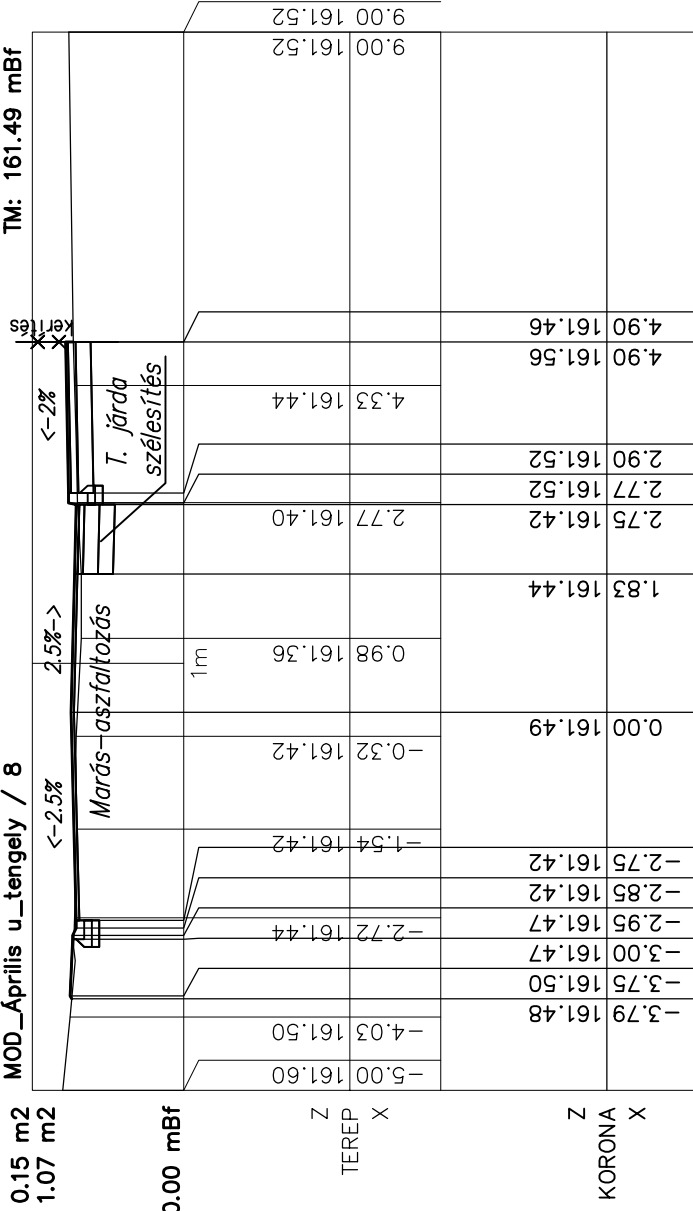

AM: 160.00 mBf

Z  
X  
TEREP

Z  
X  
KORONA

# 0+200.00

MOD\_Aprilis u\_tengely / 9  
 TÖLTÉS: 0.04 m2  
 VÁGAT: 1.35 m2

TM: 162.39 mBf

AM: 161.00 mBf

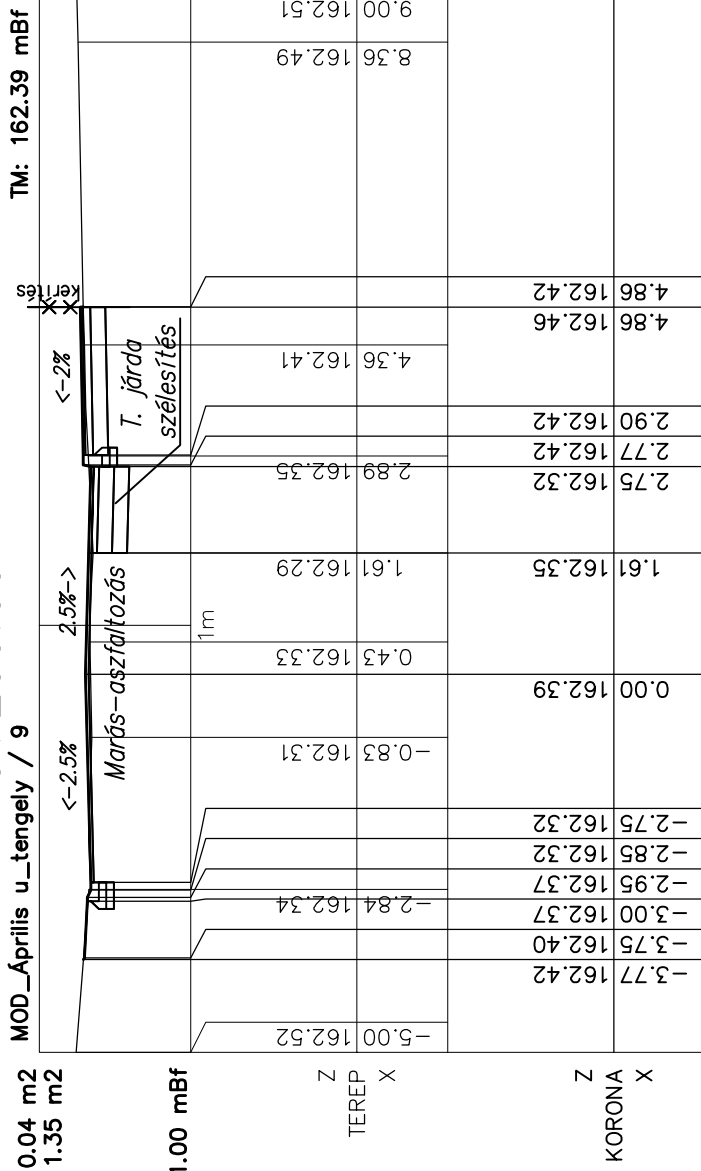

0+225.00

MOD\_Április u\_tengely / 10  
 TÖLTÉS: 0.00 m2  
 VÁGAT: 1.67 m2

TM: 163.10 mBf

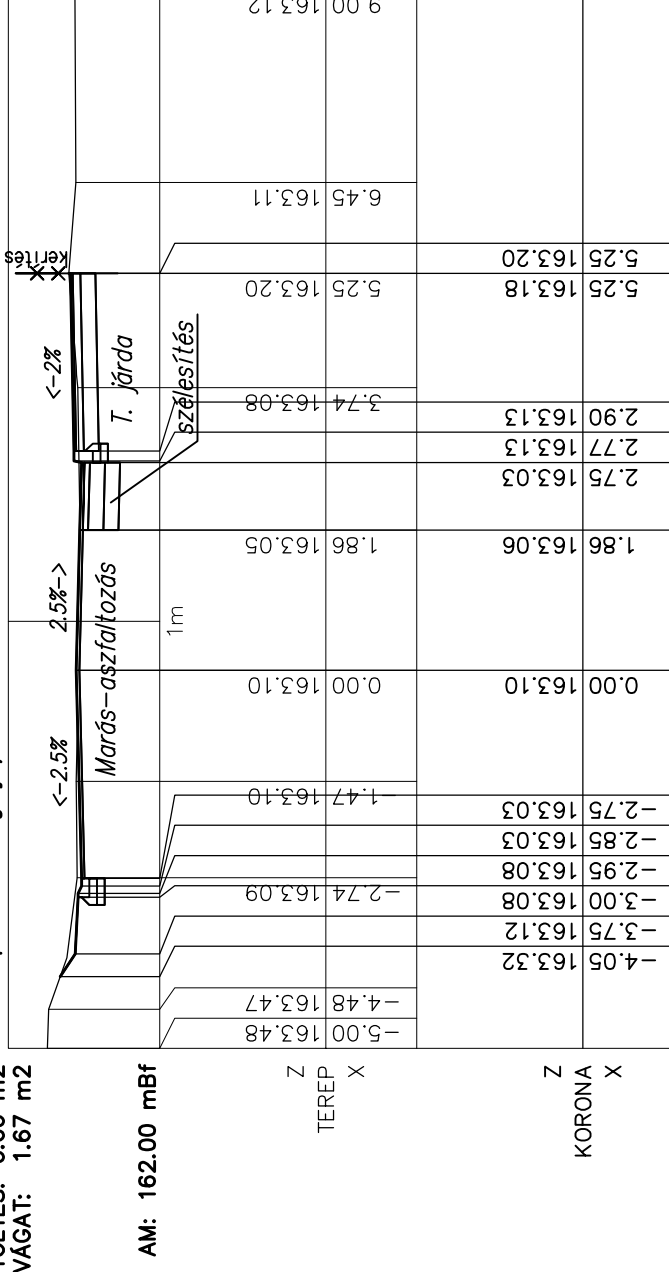

AM: 162.00 mBf

# 0+250.00

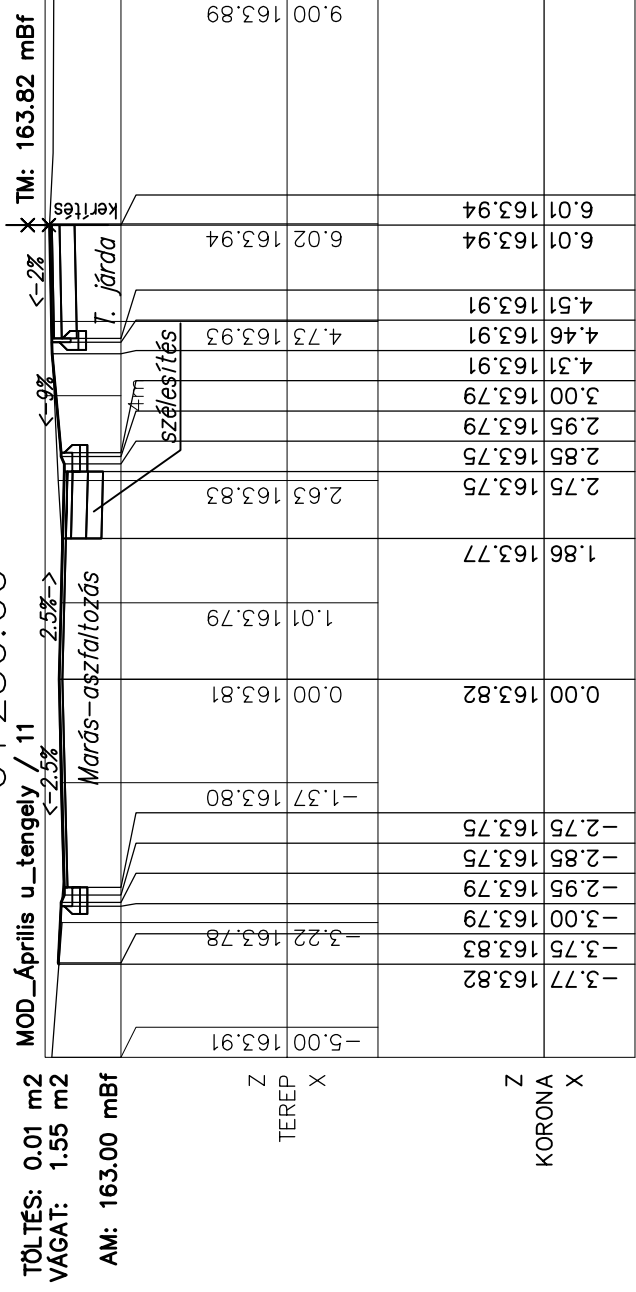

**TÖLTÉS:** 0.01 m2  
**VÁGAT:** 1.55 m2  
**AM:** 163.00 mBf

TEREP		KORONA	
Z	X	Z	X
-5.00	163.91	-3.77	163.82
-3.22	163.78	-3.75	163.83
-3.00	163.79	-2.95	163.79
-2.85	163.75	-2.85	163.75
-2.75	163.75	-2.75	163.75
-1.57	163.80	0.00	163.82
0.00	163.81	1.86	163.77
1.01	163.79	2.75	163.75
2.63	163.83	2.85	163.75
2.75	163.75	2.95	163.79
2.85	163.75	3.00	163.79
2.95	163.79	4.31	163.91
2.95	163.79	4.46	163.91
4.31	163.91	4.51	163.91
4.73	163.93	6.01	163.94
6.02	163.94	6.01	163.94
9.00	163.89		

0+275.00

MOD\_Április u\_tengely / 12  
 TÖLTÉS: 0.08 m2  
 VÁGAT: 1.31 m2

TM: 164.53 mBf

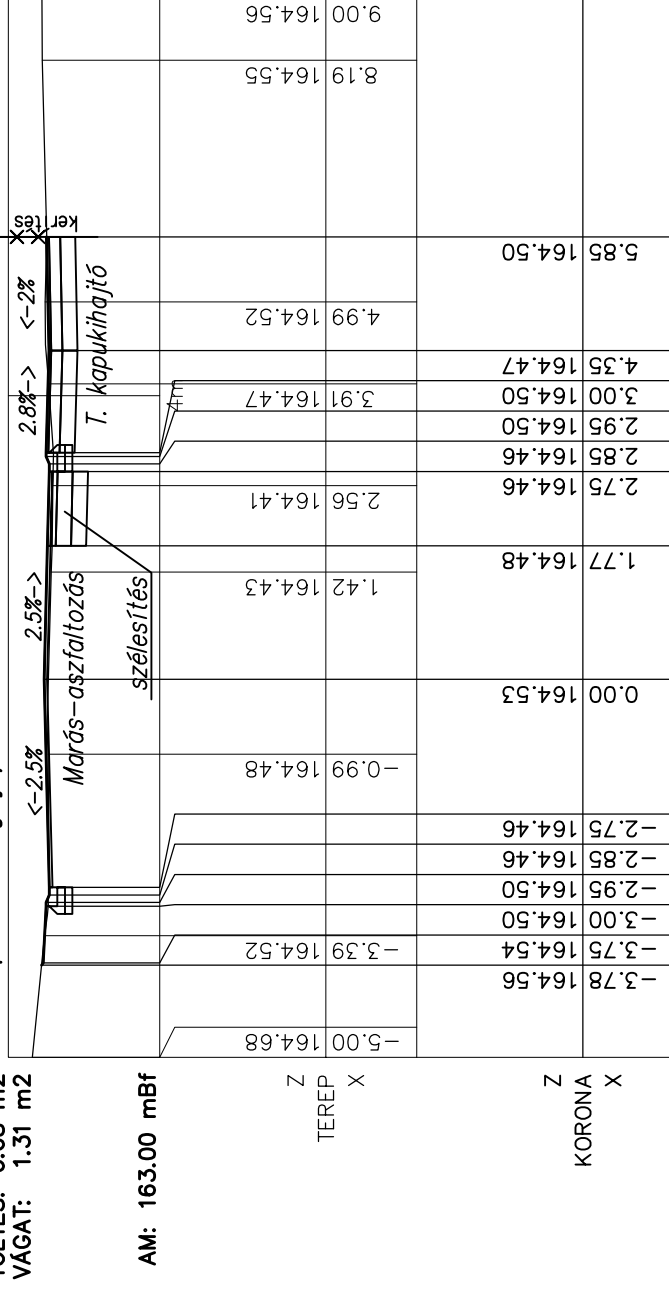

AM: 163.00 mBf

0+300.00

TÖLTÉS: 0.13 m<sup>2</sup>  
VÁGAT: 1.31 m<sup>2</sup>

TM: 165.24 mBf

MOD\_Aprilis u\_tengely / 13

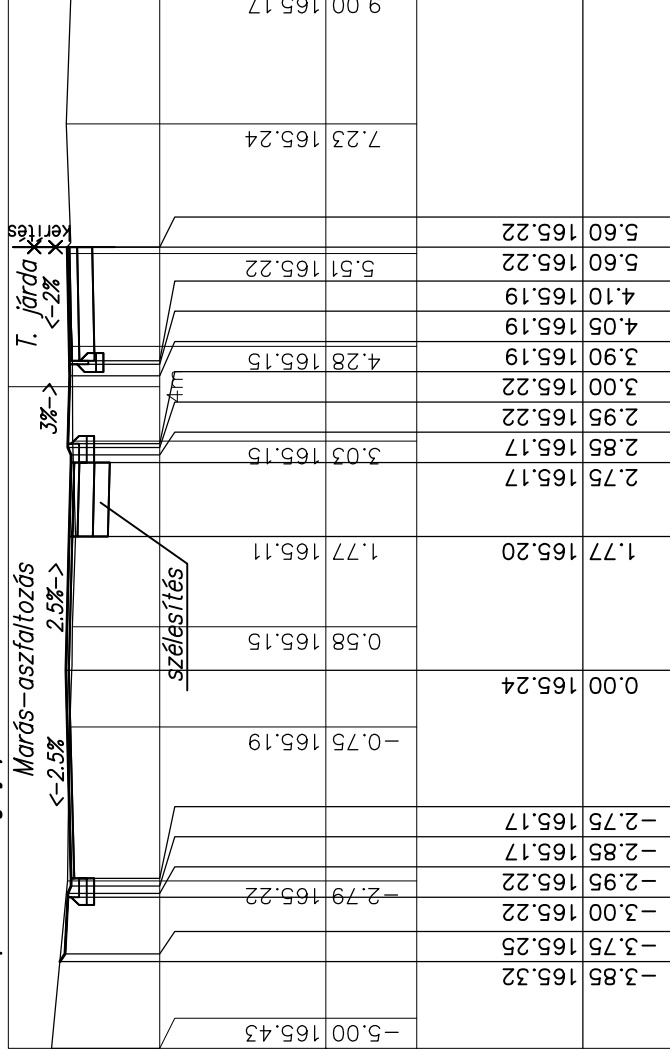

AM: 164.00 mBf

0+325.00

TÖLTÉS: 0.00 m<sup>2</sup>  
VÁGAT: 1.55 m<sup>2</sup>

TM: 165.95 mBf

MOD\_Április u\_tengely / 14

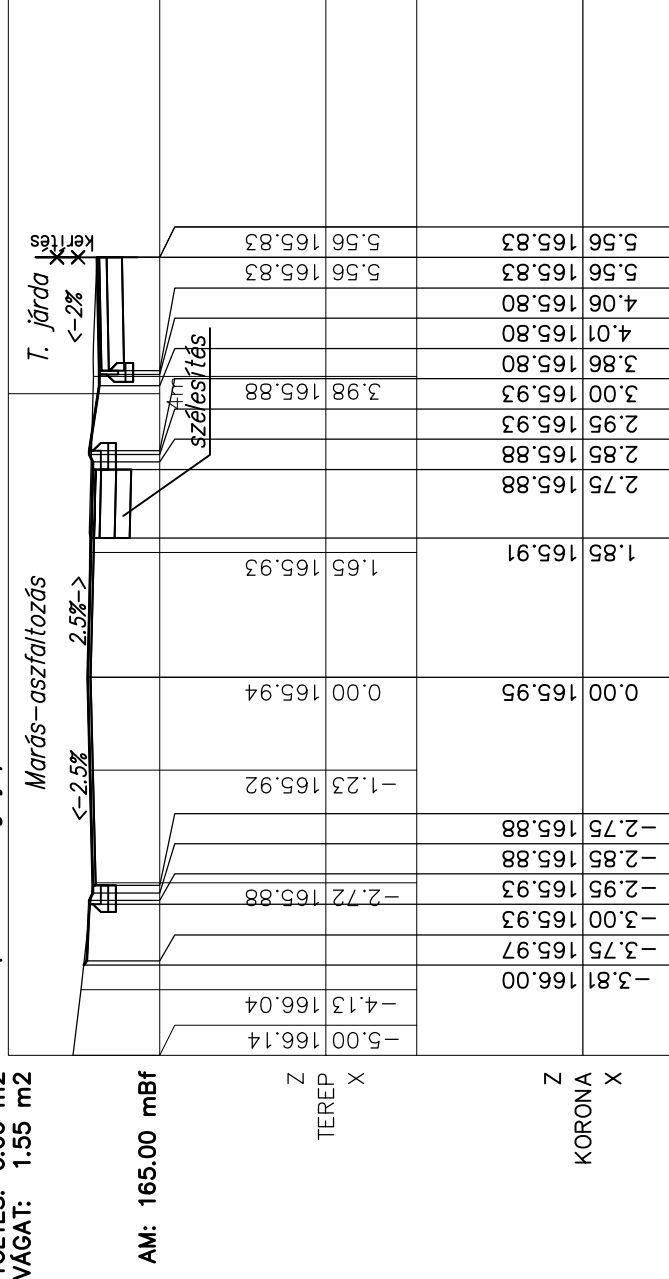

AM: 165.00 mBf

Z  
X  
TEREP

Z  
X  
KORONA



# 0+350.00

**TÖLTÉS:** 0.23 m<sup>2</sup>  
**VÁGAT:** 1.41 m<sup>2</sup>  
**AM:** 166.00 mBf

TM: 166.66 mBf

MOD\_Április u\_tengely / 15

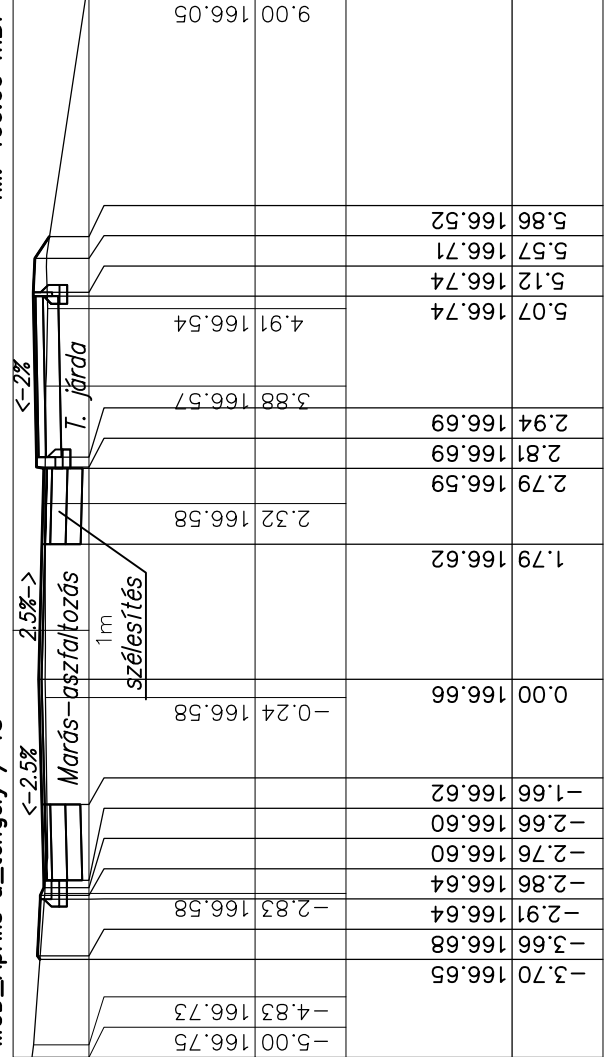

TEREP	X	Z
-5.00	166.75	
-4.83	166.73	
-3.70	166.65	
-3.66	166.68	
-2.91	166.64	
-2.86	166.64	
-2.76	166.60	
-2.66	166.60	
-1.66	166.62	
0.00	166.66	
1.79	166.62	
2.79	166.59	
2.81	166.69	
2.94	166.69	
5.07	166.74	
5.12	166.74	
5.57	166.71	
5.86	166.52	
9.00	166.05	

KORONA  
 X  
 Z

TEREPI  
 X  
 Z

0+375.00

TÖLTÉS: 0.00 m<sup>2</sup>  
VÁGAT: 1.76 m<sup>2</sup>

TM: 167.15 mBf

MOD\_Április u\_tengely / 16

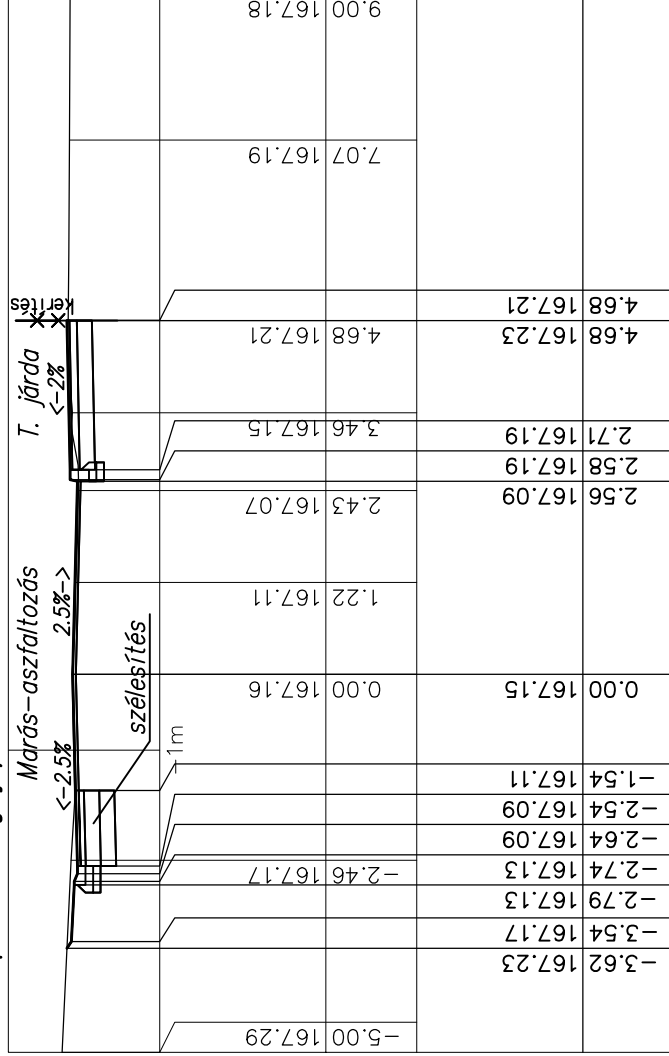

AM: 166.00 mBf

Z  
X  
TEREP

Z  
X  
KORONA

# 0+400.00

MOD\_Április u\_tengely / 17  
 TÖLTÉS: 0.01 m<sup>2</sup>  
 VÁGAT: 1.94 m<sup>2</sup>

TM: 167.26 mBf

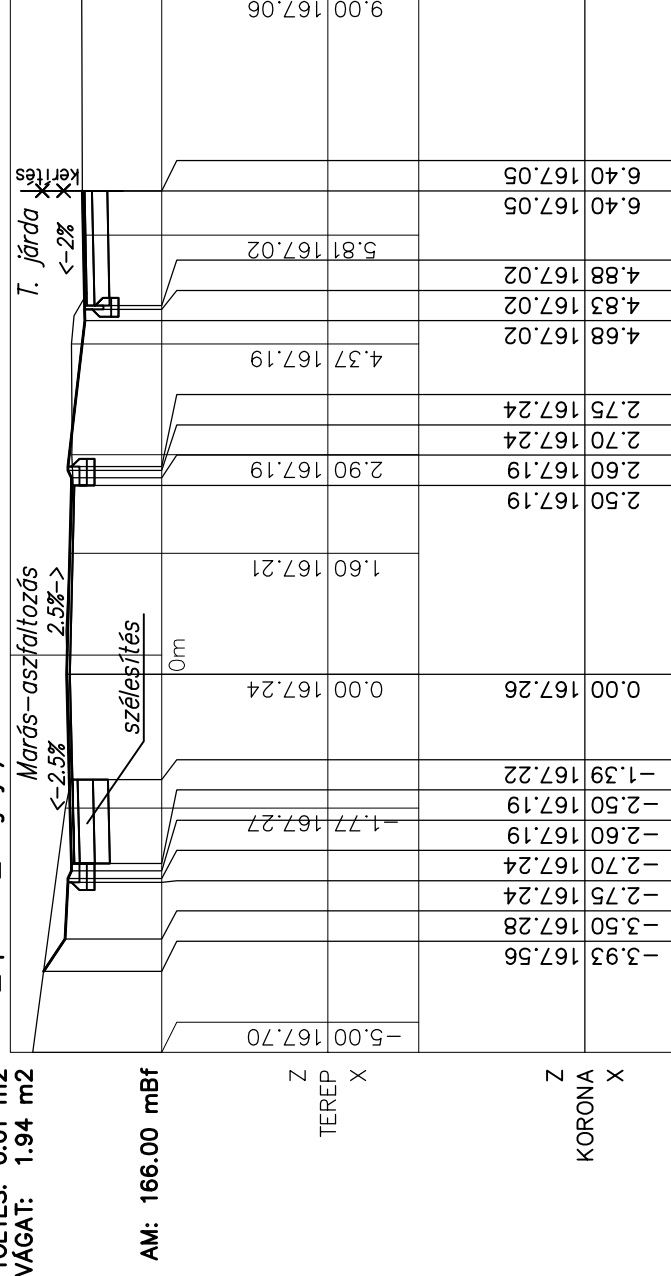

# 0+425.00

TÖLTÉS: 0.28 m2  
VÁGAT: 1.68 m2

TM: 167.21 mBf

MOD\_Április u\_tengely / 18

AM: 166.00 mBf

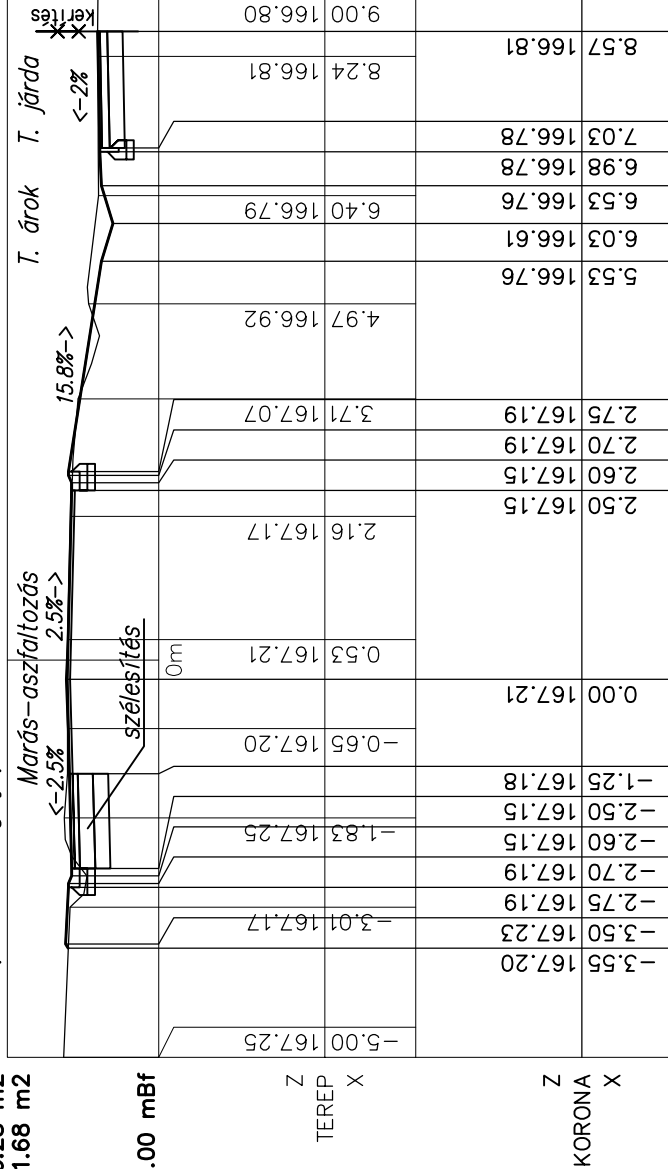

# 0+450.00

TÖLTÉS: 0.54 m2  
VÁGAT: 1.62 m2

MOD\_Április u\_tengely / 19 TM: 167.29 mBf

AM: 166.00 mBf

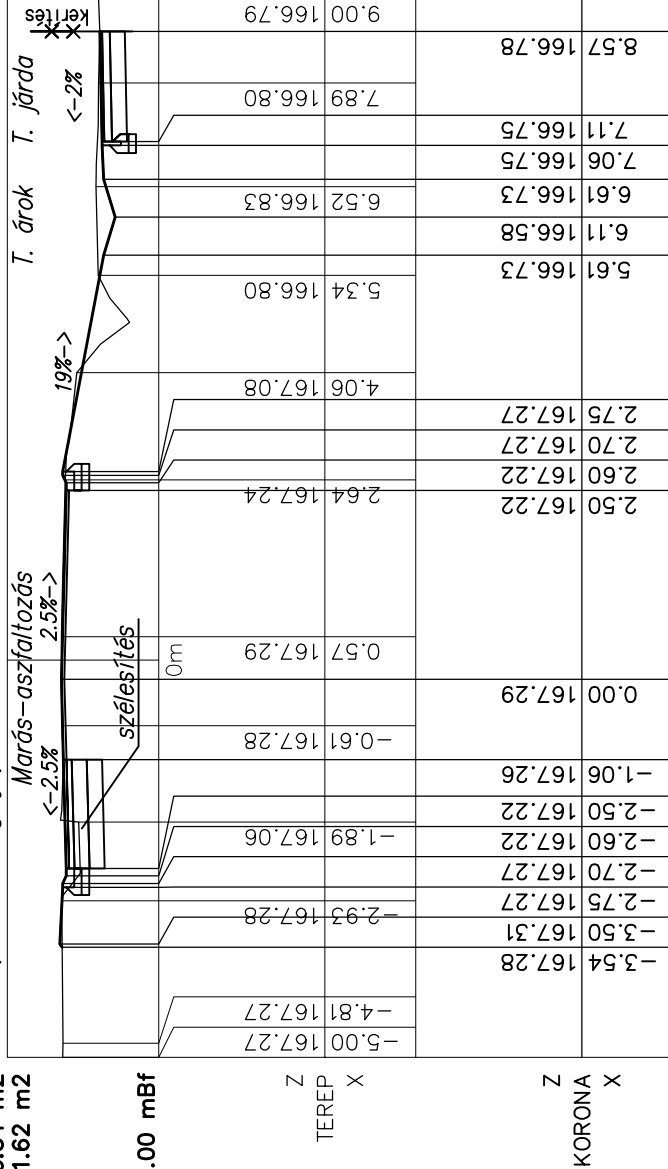

# 0+475.00

TÖLTÉS: 0.37 m<sup>2</sup>  
 VÁGAT: 1.66 m<sup>2</sup>

MOD\_Április u\_tengely / 20

TM: 167.37 mBf

AM: 166.00 mBf

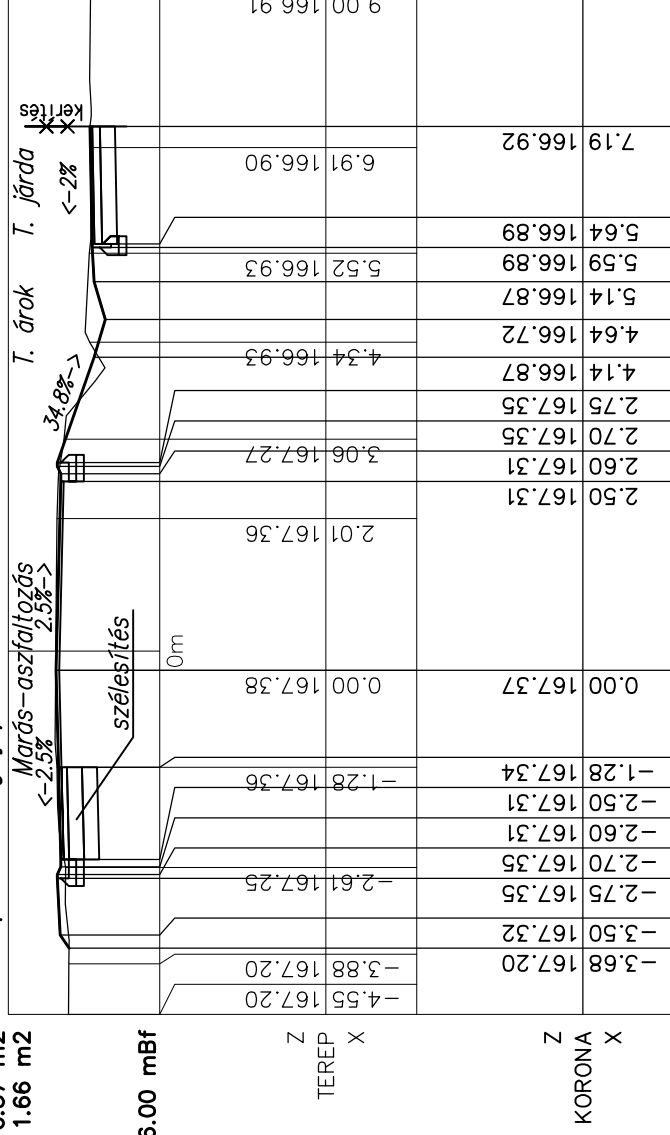

# 0+500.00

TÖLTÉS: 0.10 m<sup>2</sup>  
VÁGAT: 1.79 m<sup>2</sup>

MOD\_Aprilis u\_tengely / 21

TM: 167.68 mBf

AM: 166.00 mBf

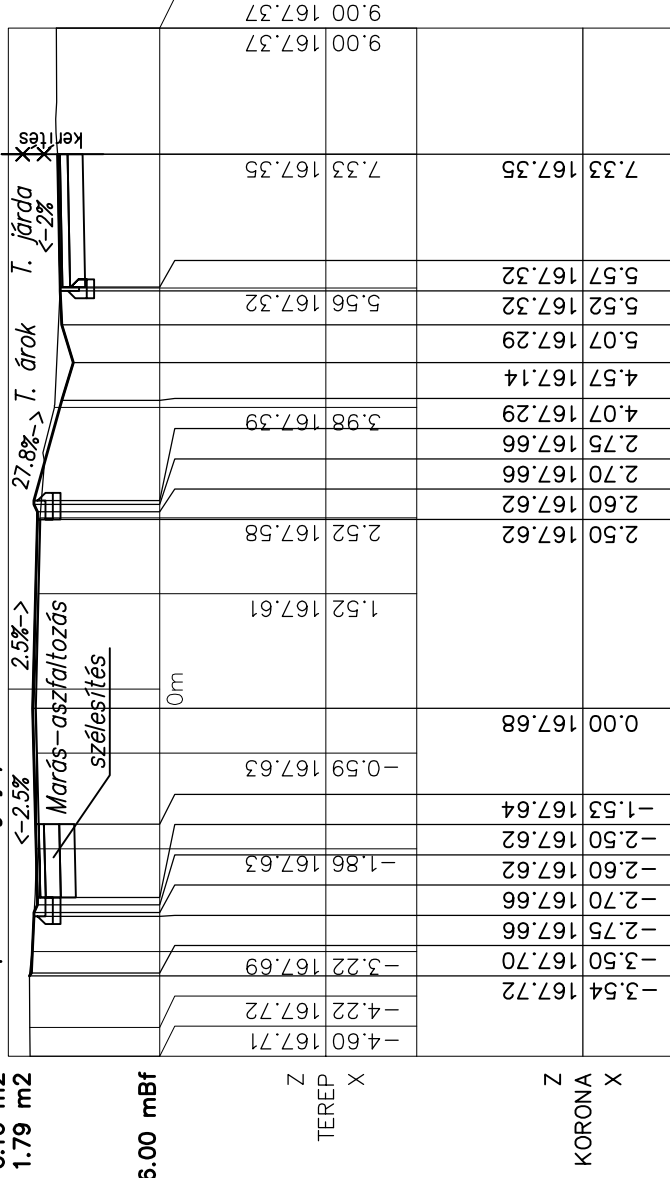

0+525.00

TÖLTÉS: 0.04 m2  
VÁGAT: 1.51 m2

TM: 168.29 mBf

MOD\_Aprilis u\_tengely / 22

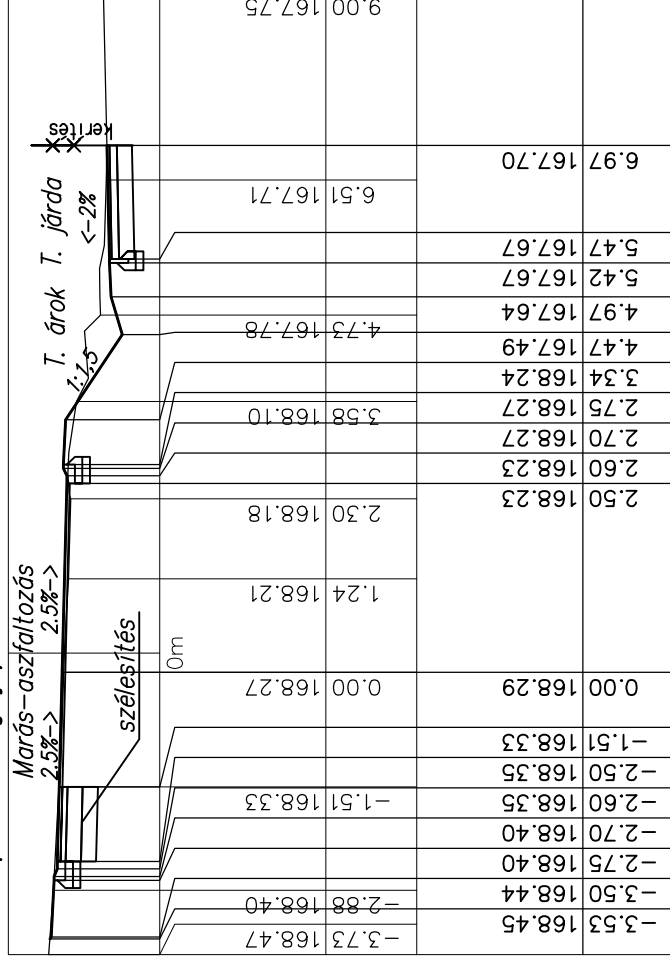

AM: 167.00 mBf

Z  
X  
TEREP

Z  
X  
KORONA

-3.53	168.45	-3.73	168.47
-3.50	168.44	-2.88	168.40
-2.75	168.40		
-2.70	168.40		
-2.60	168.35	-1.51	168.33
-2.50	168.35		
-1.51	168.33		
0.00	168.29	0.00	168.27
1.24	168.21	1.24	168.21
2.30	168.18	2.30	168.18
2.50	168.23		
2.60	168.23		
2.70	168.27		
2.75	168.27	3.58	168.10
3.34	168.24		
4.47	167.49		
4.97	167.64	4.73	167.78
5.42	167.67		
5.47	167.67		
6.97	167.70	6.51	167.71
9.00	167.75		



# 0+550.00

TÖLTÉS: 0.10 m<sup>2</sup>  
VÁGAT: 1.35 m<sup>2</sup>

MOD\_Április u\_tengely / 23

TM: 168.99 mBf

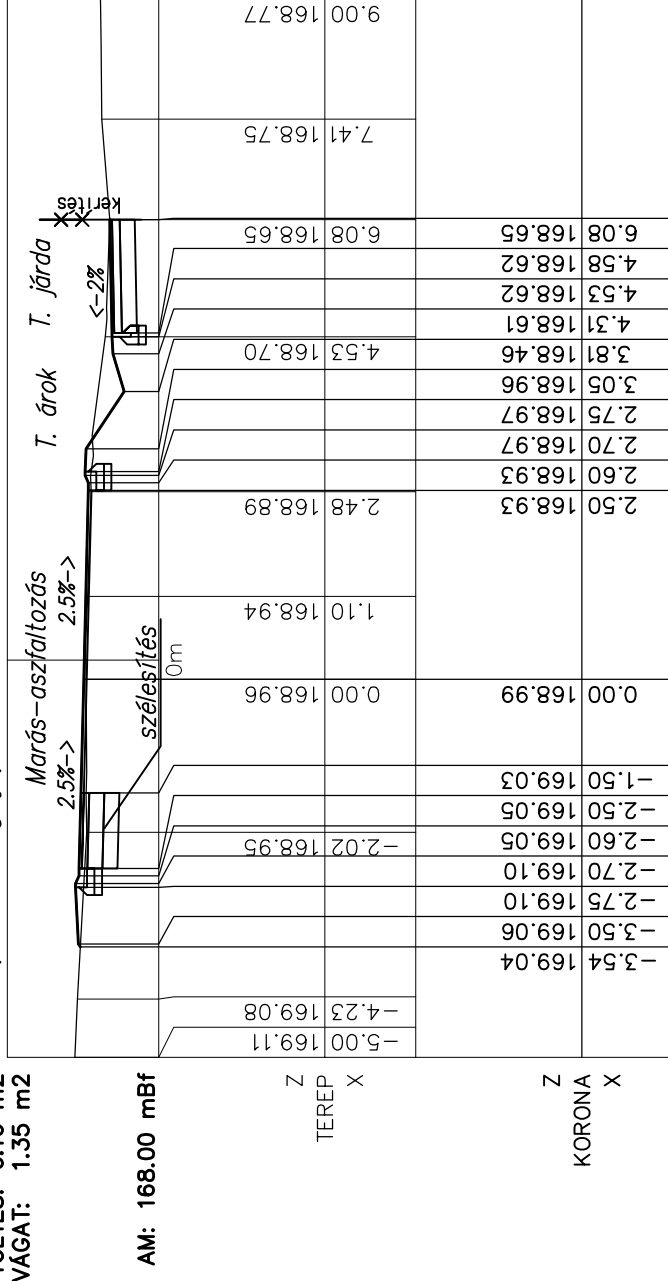

# 0+575.00

TM: 169.98 mBf

MOD\_Április u\_tengely / 24  
 TÖLTÉS: 0.09 m2  
 VÁGAT: 0.86 m2

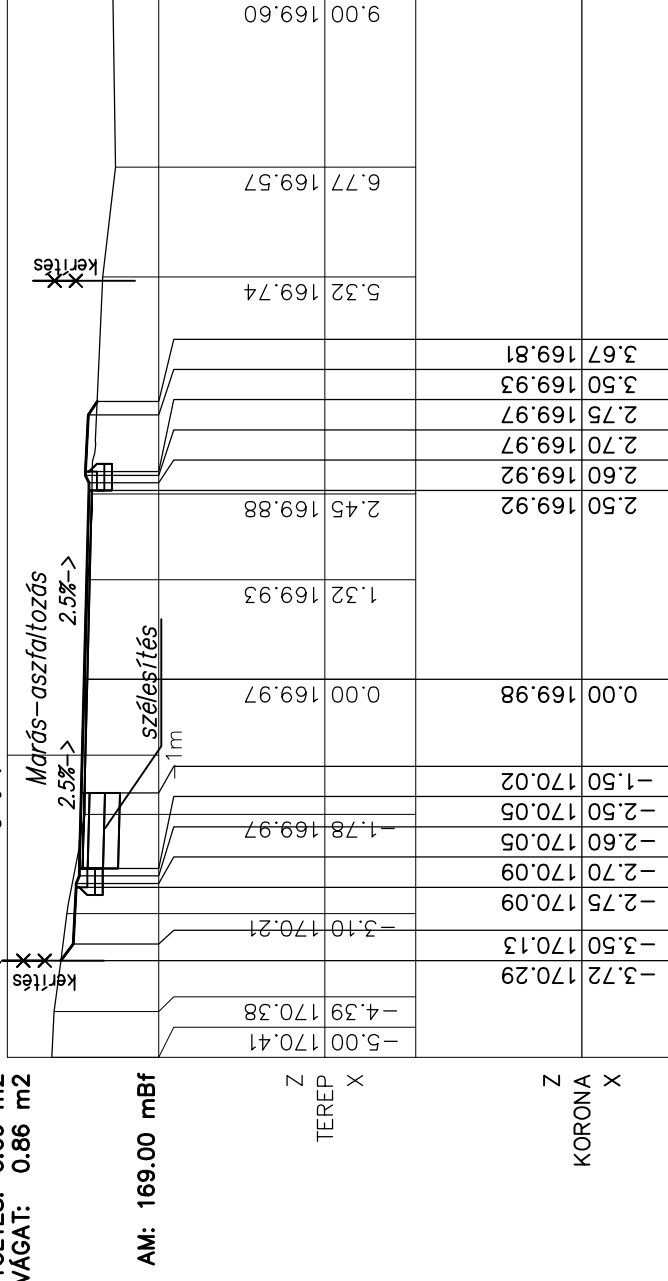

0+600.00

TM: 170.61 mBf

TÖLTÉS: 0.02 m2  
VÁGAT: 0.84 m2

AM: 170.00 mBf

MOD\_Április u\_tengely / 25

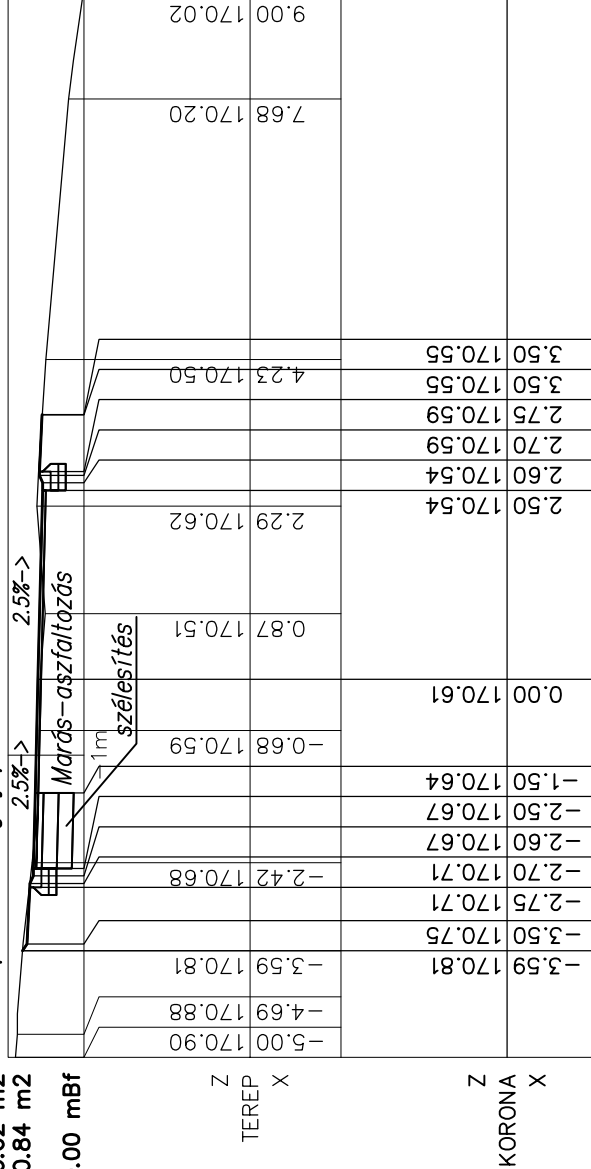

# 0+625.00

TÖLTÉS: 0.08 m2  
VÁGAT: 0.61 m2

MOD\_Április u\_tengely / 26

TM: 170.33 mBf

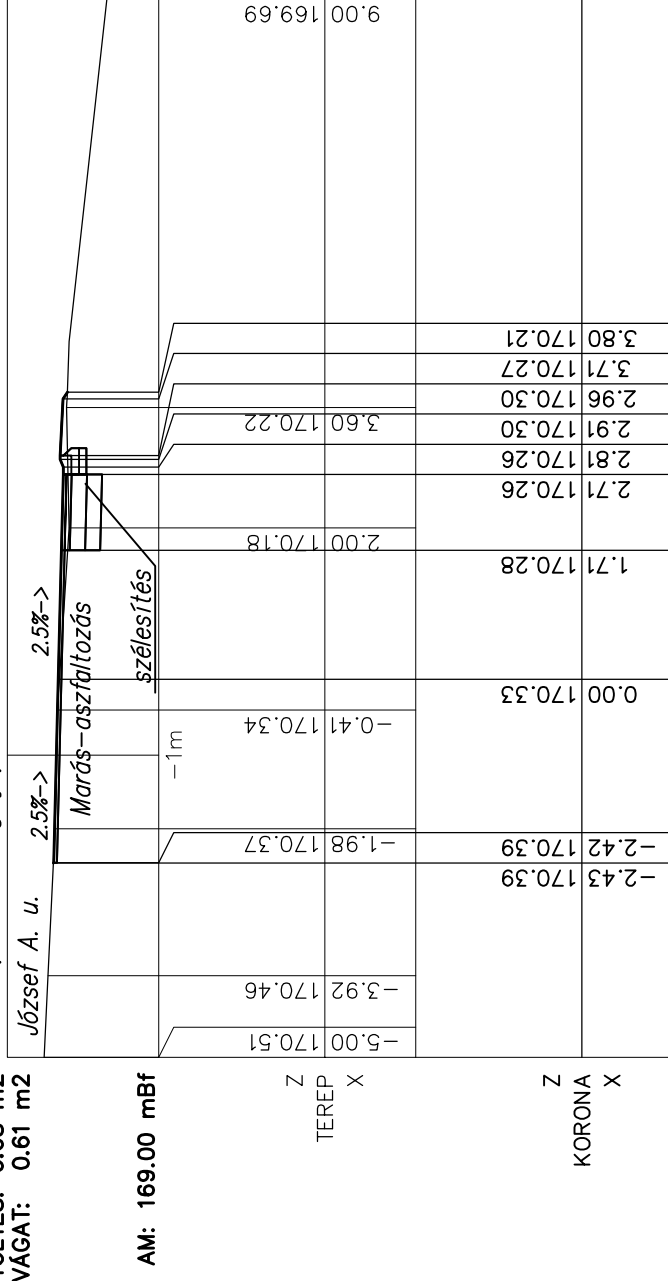

AM: 169.00 mBf

József A. u.

2.5%→

2.5%→

Marás-aszfaltozás

szélesítés

-1m

Z  
X  
TEREP

Z  
X  
KORONA

# 0+650.00

TÖLTÉS: 0.24 m2  
VÁGAT: 0.79 m2

MOD\_Aprilis u\_tengely / 27

TM: 169.89 mBf

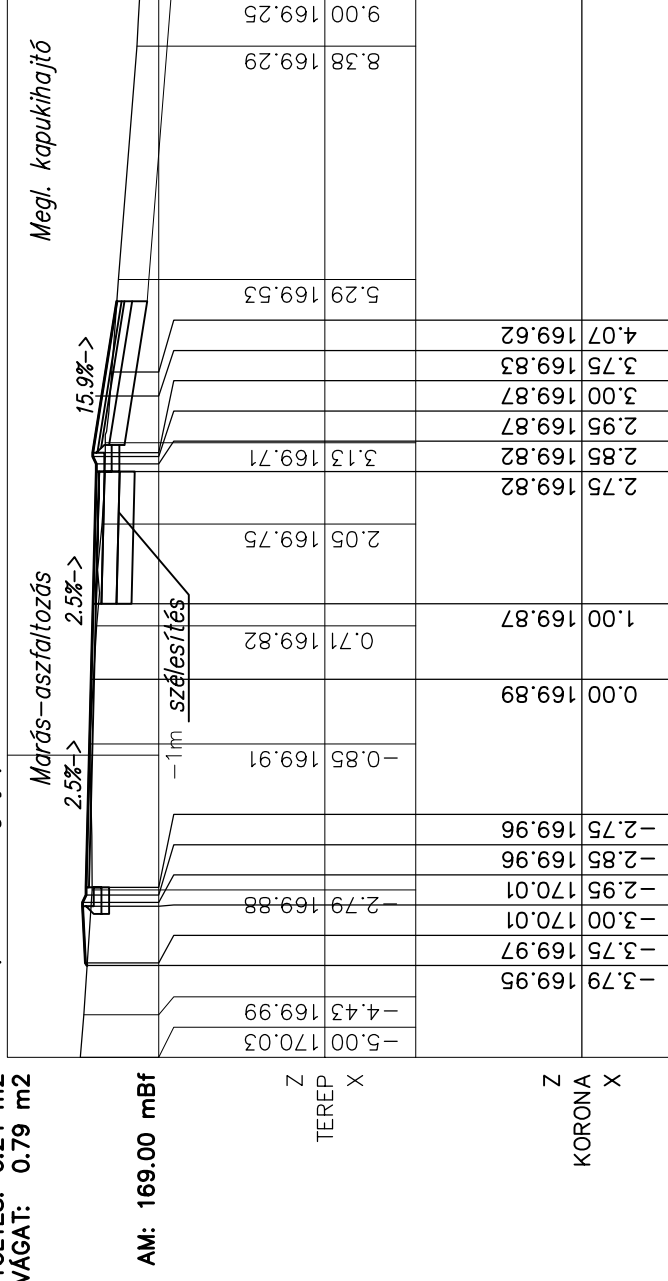

AM: 169.00 mBf

# 0+675.00

MOD\_Április u\_tengely / 28 TM: 169.64 mBf

TÖLTÉS: 0.54 m2  
VAGAT: 0.46 m2

170m

170m

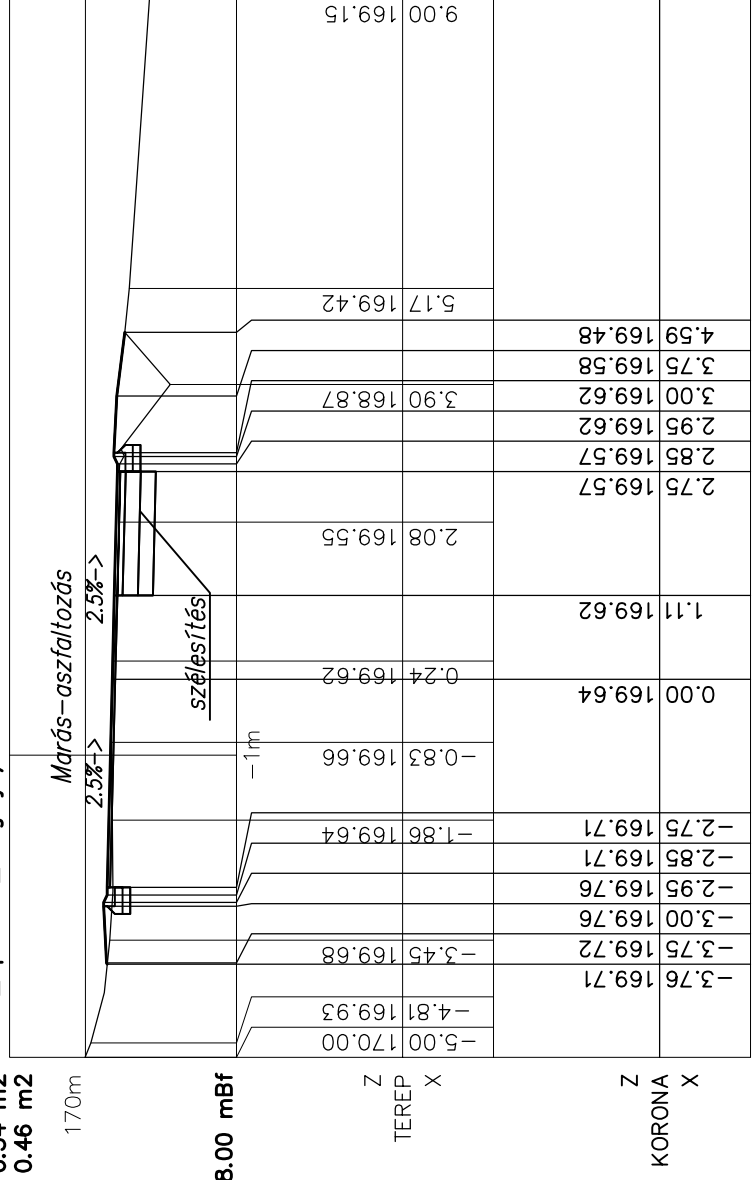

AM: 168.00 mBf

Z  
X  
TEREP

Z  
X  
KORONA

# 0+686.23

TÖLTÉS: 0.23 m<sup>2</sup>  
 VÁGAT: 0.88 m<sup>2</sup>

MOD\_Április u\_tengely / 29

TM: 169.53 mBf

AM: 168.00 mBf

